

Varenummer: 46932011
 Beskrivelse: Sikkerhedskobling Synchron A 20 S

Mål

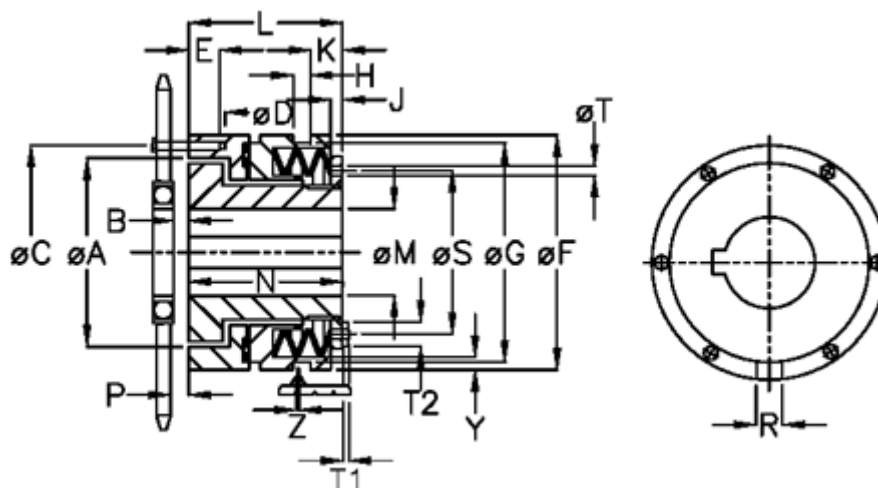

A = 41.0	J = 3.0	S = 36
B = 4.0	K = 7.5	T = 4
C = 48	L = 38.5	T1 = 3.0
D = 6xM5	M max = 20	T2 = 7
E = 6.5	M min = 7	Tallerkenfjeder montering = 6x1S
F = 55	N = 35.0	Tallerkenfjeder udførelse = S - let
G = 50.0	P = 3.1	Y = 2
H = 9	R = 6	Z = 0.1